



RAYSTAR

RAYSTAR Optronics, Inc.
曜凌光電股份有限公司



曜凌光電股份有限公司 Raystar Optronics, Inc.

42881台中市大雅區科雅路25號5樓
5F, No. 25, Keya Road, Daya Dist., Taichung City 42881, Taiwan
T : +886-4-2565-0761 | F : +886-4-2565-0760
sales@raystar-optronics.com | www.raystar-optronics.com

RL0F00050000FGAAASC00

SPECIFICATION

CUSTOMER:

APPROVED BY	
PCB VERSION	
DATE	

FOR CUSTOMER USE ONLY

SALES BY	APPROVED BY	CHECKED BY	PREPARED BY

Release DATE:

TFT Display Inspection Specification: <https://www.raystar-optronics.com/download/products.htm>
Precaution in use of TFT module: <https://www.raystar-optronics.com/download/declaration.htm>

Revision History

VERSION	DATE	REVISED PAGE NO.	Note
0	2020/09/04		First issue
A	2021/02/03		Add firmware new Object type.

Contents

1. Smart Display Classification Information
2. Summary
3. Product information
4. Contour Drawing
5. Absolute Maximum Ratings
6. Electrical Characteristics
7. BOM
8. Block diagram
9. Interface
10. Reliability
11. Product inspection check list
12. Display Usage
13. Example Screen Layout (Vehicle automotive)
14. References

1. Smart Display Classification Information

R	L	OF	000500	00F	G	A	AA	S	C	00
①	②	③	④	⑤	⑥	⑦	⑧	⑨	⑩	⑪

①	R: RAYSTAR products									
②	Type: L:Standard K:Customization									
③	Display Type:	Standard:	0H: Character STN 0X: Graphic STN (TAB/COF) 0F: TFT EH: Character OLED EX: OLED (TAB/COF)	0G: Graphic STN 0P: Graphic STN (COG) EG: Graphic OLED EP: OLED (COG)						
		Customization:	DH: Character DN: Graphic ED: OLED	DG: Graphic STN OJ: TFT						
④	Display size: (diagonal) / Display format: (resolution)	Character STN:	e.g., 8x1: 000801 16x2: 001602 24x4: 002404							
		Graphic STN:	e.g., 128x64: 012864 320x240: 320240							
		TFT Size (inch):	000096-0.96" / 000350-3.5" / 000430-4.3" / 000570-5.7" 000700-7.0" / 000800-8.0" / 001020-10.2" / 001210-12.1" (The last two digits are two digits after the decimal point)							
	OLED:	e.g., 128x64: 012864 Customization: 0001XX								
⑤	Serial No:	0A1 ~ 0ZZ	Customization STN: 000							
⑥	Touch Panel Type:	N: Without TP T: RTP G: CTP								
⑦	Model Interface:	A: CAN B: Bluetooth C: Controller Specified D: RS485 E: RS232 F: USART G: Logic I/O	H: HDMI R: Memory Specified N: Ethernet J: Analog I/O K: USB L: WIFI M: Zigbee	X: Combined Y: Proprietary interface						
⑧	Interface Serial No.:	AA ~ ZZ								
⑨	Control Category:	S: Smart Display N: Non-specified								
⑩	Special Code:	A ~ Z								
⑪	Model code:	00 ~ ZZ								

2. Summary

5 Inch Smart Display Feature

1. DC 5V working voltage, low power consumption for USB to drive.
2. Self testing after booting function.
3. CAN bus communication interface.
4. Support CANopen negotiation. Default baud rate is 250KB.
5. Embedded FLASH memory, storing Font and Object Dictionary.
6. Support capacitive touch panel (CTP).
7. Smart Display scenario is slave device display and action from Master Device instruction.
8. Embedded buzzer controlled by Master Device.
9. Demo set HOST can be used on multiple platforms, such as Computer (with USB to CAN Dongle), MCU, Raspberry Pi (with PiCAN2).

3. Product information

3.1 Mechanical Data

Item	Standard Value	Unit
LCD panel	120.7(W)*75.8(H)*4.475	mm
PCB	132.7(W)*75.8(H)*1.6	mm
Housing outline	NA	mm

3.2 General information

Item	Standard Value	Unit
Operating voltage	5	Vdc
Communication Interface	CAN bus differential ± 3.3	Vpp
LCD display size	5.0	inch
Dot Matrix	800× 3(RGB) × 480	dot
Module dimension	120.7(W) ×75.8(H) ×4.475	mm
Active area	108(W) ×64.8 (H)	mm
Dot pitch	0.135(W) ×0.135(H)	mm
LCD type	TFT, Normally Black, Transmissive	
View Direction	80/80/80/80	
Aspect Ratio	16:9	
With /Without TP	With CTP	
Surface	Glare	

4. Contour Drawing

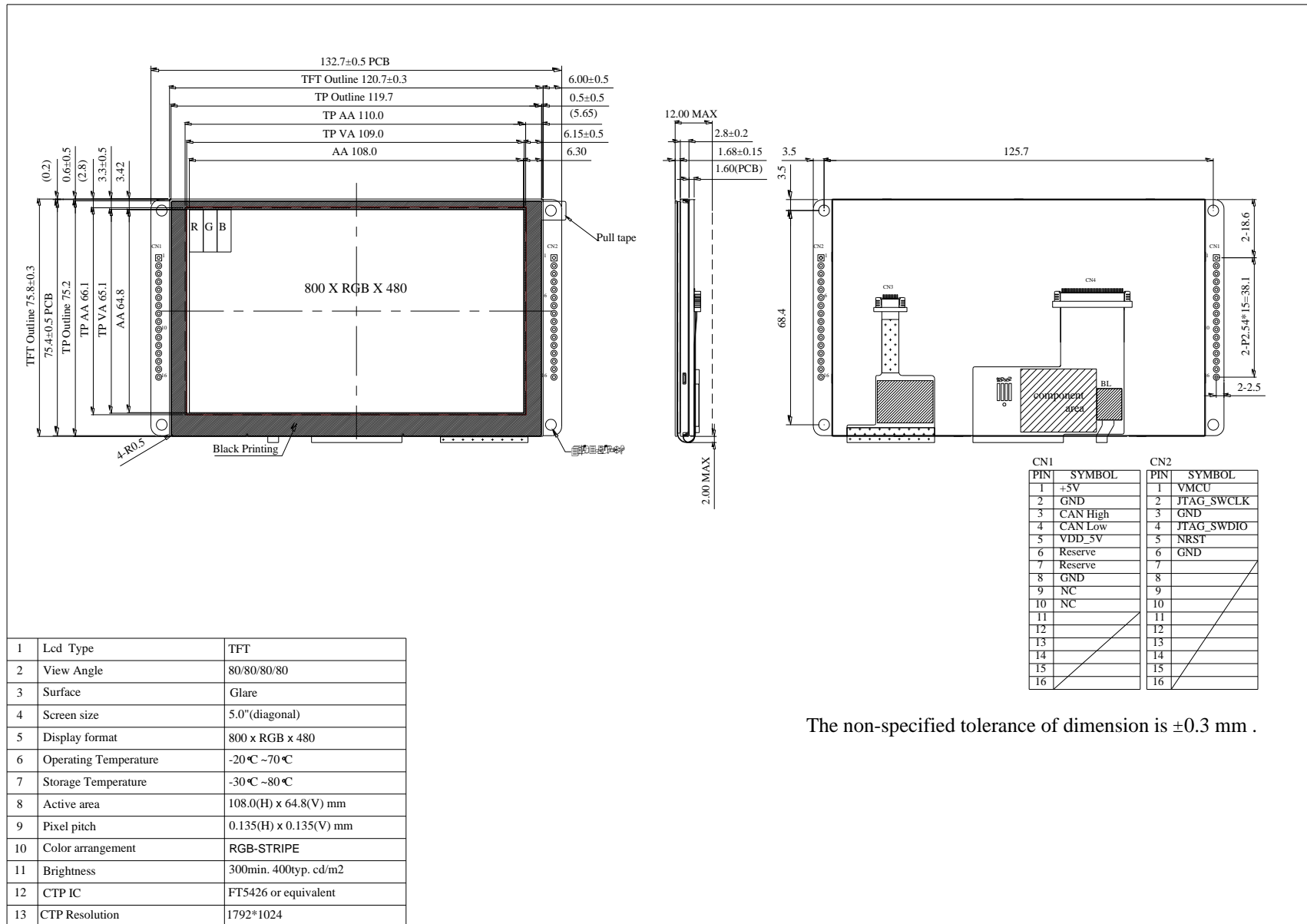

The non-specified tolerance of dimension is ±0.3 mm .

5. Absolute Maximum Ratings

Item	Symbol	Min	Typ	Max	Unit
Operating Temperature	TOP	-20	—	+70	°C
Storage Temperature	TST	-30	—	+80	°C

Note: Device is subject to be damaged permanently if stresses beyond those absolute maximum ratings listed above
1. Temp. $\leq 60^{\circ}\text{C}$, 90% RH MAX. Temp. $> 60^{\circ}\text{C}$, Absolute humidity shall be less than 90% RH at 60°C

6. Electrical Characteristics

6.1. Operating conditions:

Item	Symbol	Condition	Min	Typ	Max	Unit
Supply Voltage For Analog	VCI	—	4.75	5	5.5	V
Interface Operation Voltage	IOVCC	—	3.234	3.30	3.367	V
Supply LCM current	ICI(mA)	—	320	350	-	mA

6.2. LED driving conditions:

Parameter	Symbol	Min.	Typ.	Max.	Unit	Remark
LED current		-	1.0	1.5	mA	
Power Consumption		-	-	27	mW	
LED voltage	VBL+	-	-	18	V	Note 1
LED Life Time		-	50,000	-	Hr	Note 2,3,4

Note 1 : There are 1 Groups LED

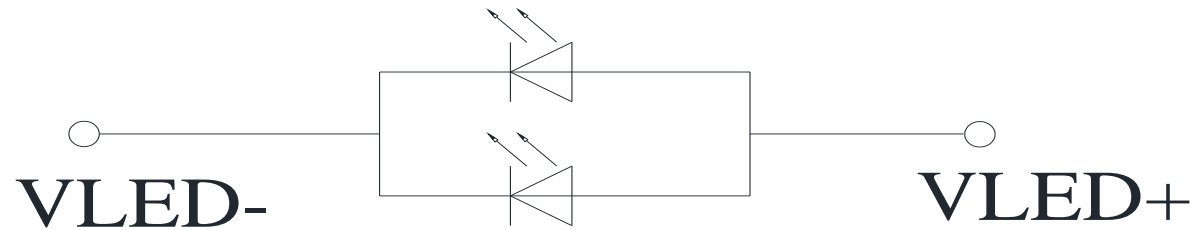

Note 2 : $T_a = 25\text{ }^\circ\text{C}$

Note 3 : Brightness to be decreased to 50% of the initial value

Note 4 : The single LED lamp case

7. BOM

Item	Description	Remark
LCM	RFF500F-AYW-DNG —	
PCBA	4 layer FR4, 1.6mm	

8. Block diagram

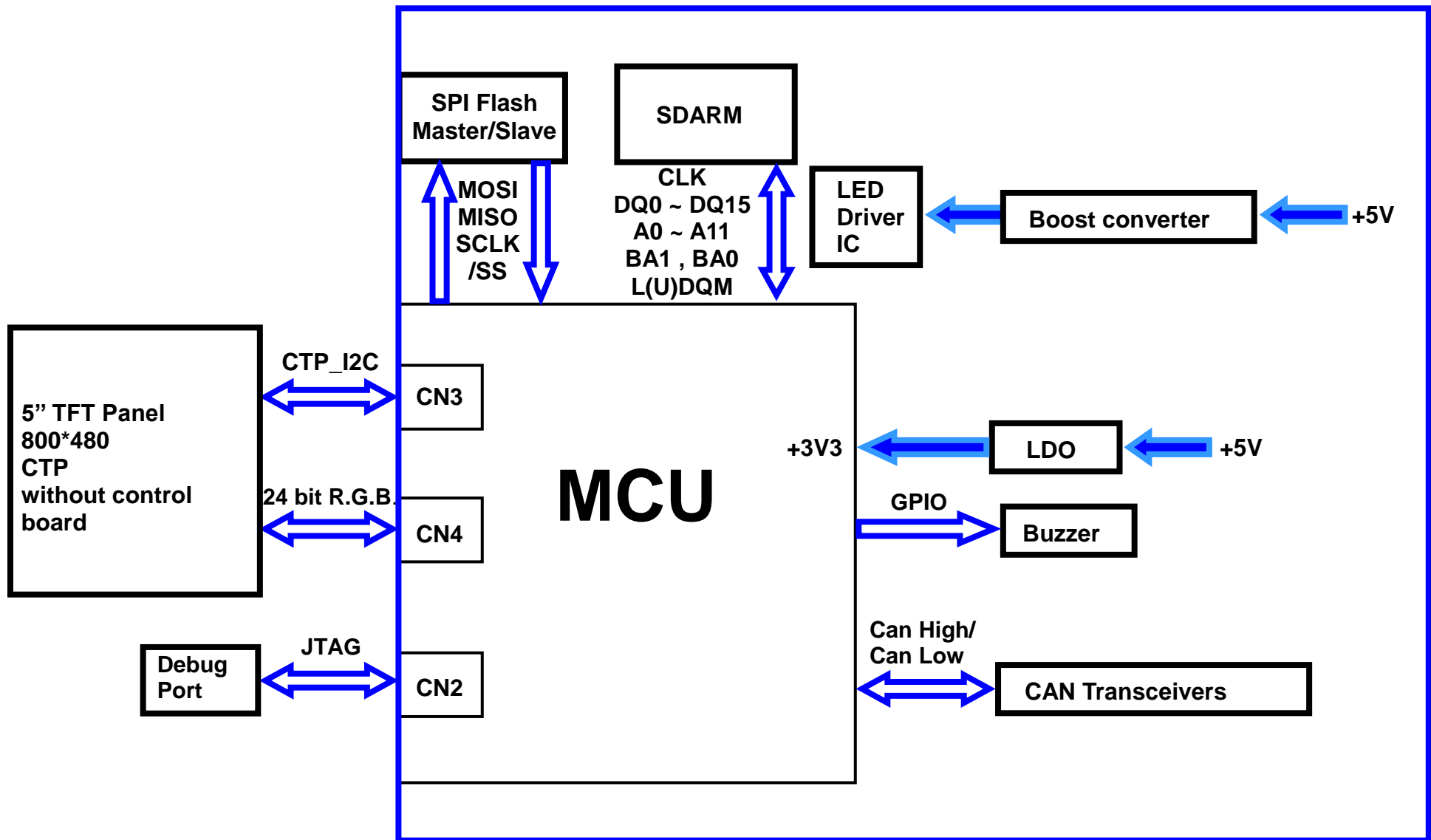

9. Interface

CN1 definition:

Pin	Symbol	Function	Remark
1	+5V	Power supply 5V input	Input
2	GND	Power supply GND input	Input
3	CAN_High	CAN bus D+	I/O
4	CAN_Low	CAN bus D-	I/O
5	VDD_5V	5V output for USART interface	Output
6	USART1_RX	USART RX interface	Reserve
7	USART1_TX	USART TX interface	Reserve
8	GND	GND for USART interface	Output
9-16	NC	Connection	-

CN2 definition:

Pin	Symbol	Function	Remark
1	VMCU	3.3V power for JTAG interface	Output
2	JTAG_SWCLK	CLK pin for JTAG interface	Input
3	GND	GND for JTAG interface	Output
4	JTAG_SWDIO	Data pin for JTAG interface	I/O
5	NRST	Reset pin for JTAG interface	Input
6	GND	GND	Output
7-16	NC	Connection	-

10. Reliability

Content of Reliability Test (Wide temperature, -20°C~70°C)

Environmental Test			
Test Item	Content of Test	Test Condition	Note
High Temperature storage	Endurance test applying the high storage temperature for a long time.	80°C 96hrs	2
Low Temperature storage	Endurance test applying the low storage temperature for a long time.	-30°C 96hrs	1,2
High Temperature Operation	Endurance test applying the electric stress (Voltage & Current) and the thermal stress to the element for a long time.	70°C 96hrs	—
Low Temperature Operation	Endurance test applying the electric stress under low temperature for a long time.	-20°C 96hrs	1
High Temperature/ Humidity Operation	The module should be allowed to stand at 40°C,90%RH max	40°C,90%RH 96hrs	1,2
Thermal shock resistance	The sample should be allowed stand the following 10 cycles of operation <div style="text-align: center;"> <p style="margin: 0;">-20°C 25°C 70°C</p> <p style="margin: 0;">30min 5min 30min</p> <p style="margin: 0;">1 cycle</p> </div>	-20°C/70°C 10 cycles	—
Vibration test	Endurance test applying the vibration during transportation and using.	Total fixed amplitude : 1.5mm Vibration Frequency : 10~55Hz One cycle 60 seconds to 3 directions of X,Y,Z for Each 15 minutes	3
Static electricity test	Endurance test applying the electric stress to the terminal.	VS=±600V(contact) ,±800v(air), RS=330Ω CS=150pF 10 times	—

Note1: No dew condensation to be observed.

Note2: The function test shall be conducted after 4 hours storage at the normal Temperature and humidity after remove from the test chamber.

Note3: The packing have to including into the vibration testing.

11. Product inspection check list

Check samples by meter V_{IN} , I_{system}

Item	No 1	No 2	No 3	Note
V_{IN} (V)	5	5	5	
I_{System} (mA)	382	387	387	

Check sample Reliability Test

Item	Result	Note
Thermal shock	PASS_20200219	-20°C/70°C 20 cycles
High Temperature Operation	PASS_20200225	70°C 96hrs
Low Temperature Operation	PASS_20200302	-20°C 96hrs
Static electricity test	PASS_20200402	VS=±600V(contact),±800v(air), RS=330Ω CS=150pF 10 times
Vibration test	—	Total fixed amplitude : 1.5mm Vibration Frequency : 10~55Hz One cycle 60 seconds to 3 directions of X,Y,Z for Each 15 minutes

- Prepare sets for testing

12. Display Usage

Functional description

Smart Display can be used to display the coordinate, status and data information provided by the connected HOST device. Customers can configure the position coordinates they want to display in normal operation mode (COB-ID = 0x7B).

The Display is designed to be easily connected to a controller network, and to operate with minimum setup or knowledge of the SDO configuration on the controllers.

Splash Screen

The default splash image is shown below.

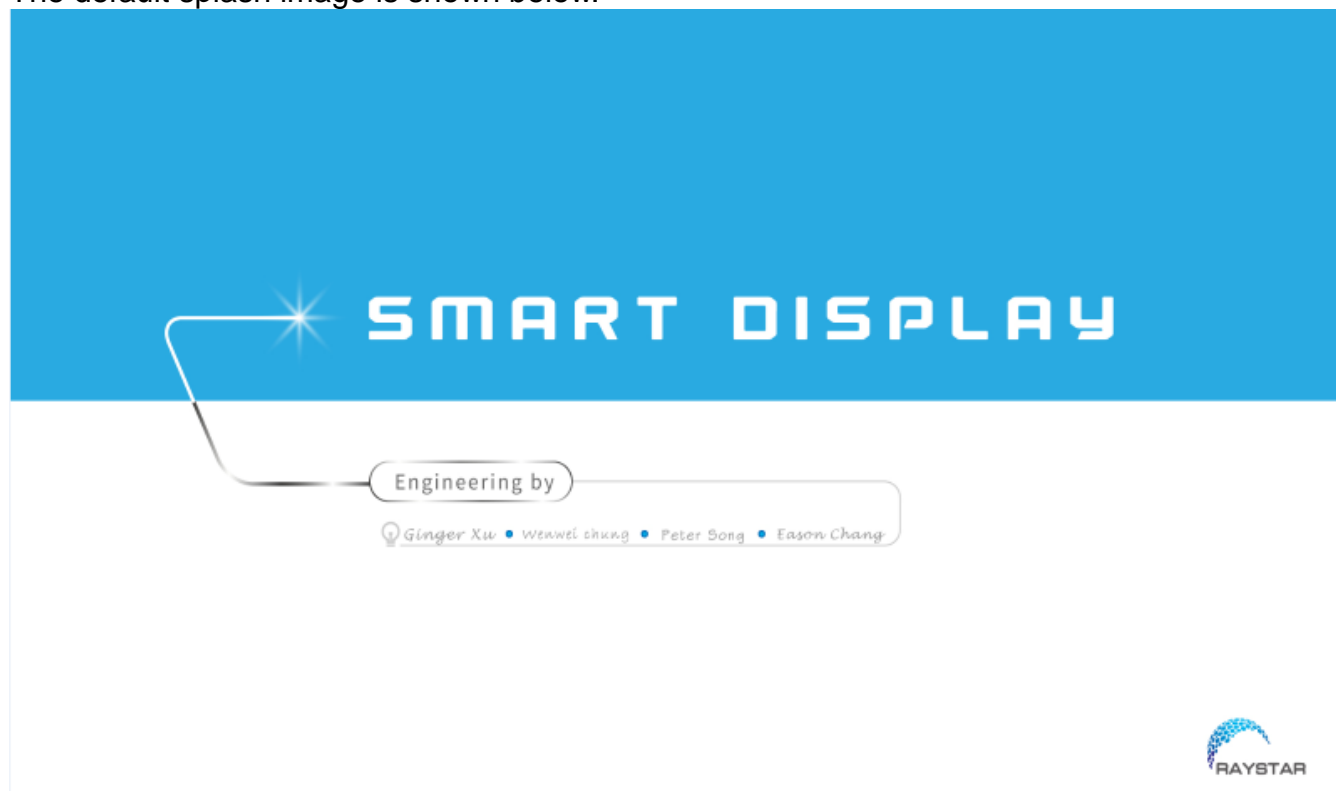

- ✓ This product is produced as a generic product. If you require a custom splash image for your application, contact us to discuss.

Acquisition of Displayed Data

The Smart Display can acquire the data that it displays either using the CANopen SDO protocol, or using the CANopen PDO protocol.

On Pre-operational mode, customers can set the coordinates of objects through SDO; On operational mode, customers can send data of objects through PDO.

Configuring the Display

Raystar Smart Display CAN series offers an out-of-the-box CANopen development experience that will lower customers' development costs and speed time-to-market expectations.

The Smart Display can use wide-temperature are designed to support control applications in harsh operating conditions, which designed to be connected to a variety of different situation combinations, such as automotive, marine, power generation and oil-and-gas.

The Smart Display comes with standard UI objects to get customers project off the ground quickly. If customers need custom UI objects support, our engineers are here to help. Send over your contents in PNG/JPG format, we will send over a new set of UI objects within 3~5 working days.

The Smart Display is defined as a slave device, which is controlled by master device via CAN bus command to render display content on the display screen and return touch event data with protocol objects.

Node ID when Standalone

If the display is powered up standalone, the node id will default to 0x7B.

Configuring the Main Screen

The screen on the display is 800 x 480 pixels.

The co-ordinate system used to specify the location of an item on the screen is shown in the diagram below. The coordinates are (x,y) where 'x' is the horizontal offset from the left, and 'y' is the vertical offset from the top.

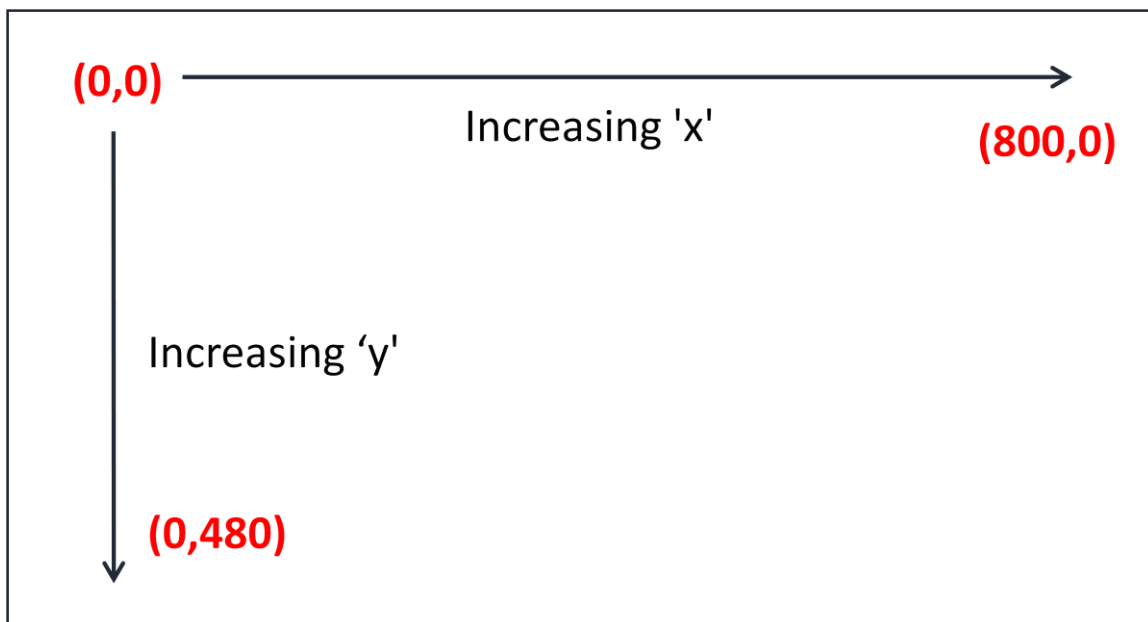

Item Object Dictionary

There are 10 objects entries which are for configuration of the items that can be displayed on the screen. These are at location 0x2000 to 0x2009. Each object fully defines one screen item.





Each item has a set of sub-index items which are used to control the coordinate of the item. The exact functionality varies depending on the type of item selected. The template object is shown below:





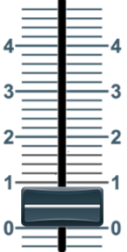

Object List(0x2000 to 0x2009)

Object Index 0x2000 to 0x2009	Name	type	Description
Sub 0	Number of Entries	UNSIGNED8	9
Sub 1	Type	UNSIGNED8	style of Object
Sub 2	Reserve		
Sub 3	X position	INTEGER16	The object's X position
Sub 4	Y position	INTEGER16	The object's Y position
Sub 5	Number of Style	INTEGER16	The photo of style
Sub 6	Reserve		
Sub 7	Value 1	UNSIGNED16	Data to smart display from HOST
Sub 8	Value 2	UNSIGNED16	Data from smart display to HOST
Sub 9	Reserve		

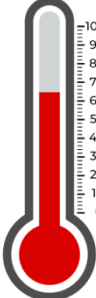
Sub 1 – Type

The item type is selected according to the table below:

Data	Description	Example Image
0	No Item This entry is not used	
1	Reserve	
2	Gauge	
3	Reserve	
4	Button	
5	Toggle Button	
6	Vertical Slider	
7	Horizontal Slider	
8	Check Box	







9	Temperature	
10	Battery	
11	Graph	
12	Indicator	
13	CircleProgress	
14	ImageProgress	
15	Progressive button	
17	Number String	65535
18	Text String	ABC





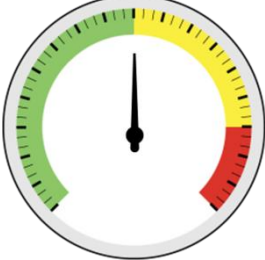



Sub 3&4 – x and y position

Each item is drawn on screen by setting a draw rectangle. This rectangle is a bounding rectangle sized to fully enclose the item that is being drawn. The co-ordinates specify the position of the top left of this bounding rectangle.

Sub 5 –Number of Style

Various types of icons

Gauge	icon
0	
1	
2	
3	
4	
5	

Button	icon
0	 A vertical slider icon with a white track and a white knob at the bottom.
1	 A circular button icon with a green center and a grey outer ring.
2	 A horizontal toggle switch icon with a white knob on the left and a blue dot on the right.
3	 A horizontal toggle switch icon with a white knob on the left and a grey track on the right.
4	 A horizontal slider icon with a grey track and a white knob on the left.
5	 A horizontal slider icon with a grey track and a white knob on the left, enclosed in a black rectangular border.
6	 A vertical slider icon with a white track and a black knob at the top.
7	 A circular metallic button icon with a silver finish and a central hole.

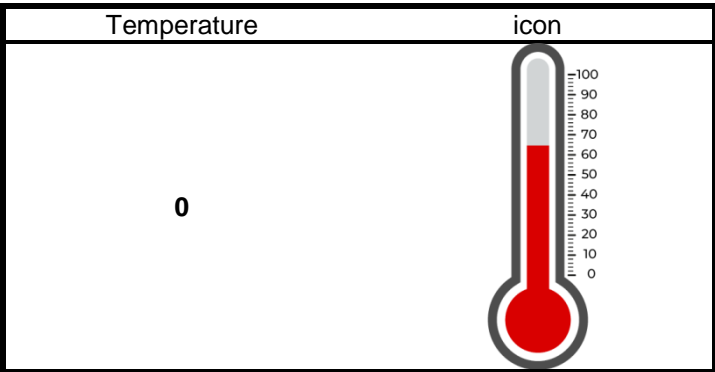
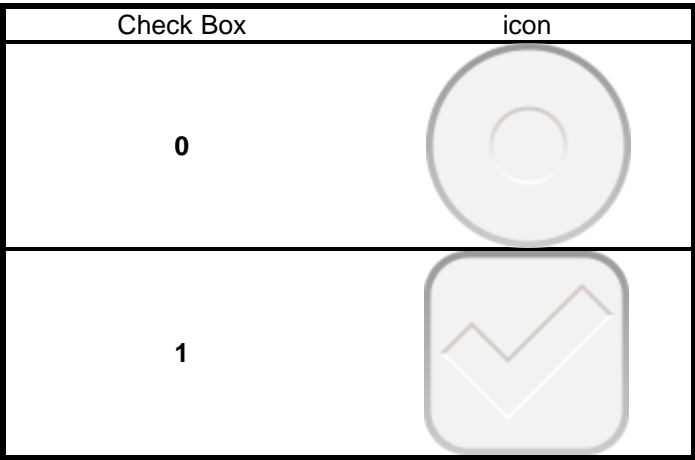
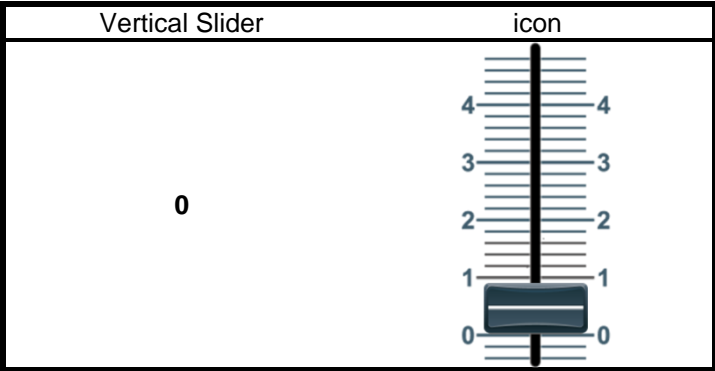
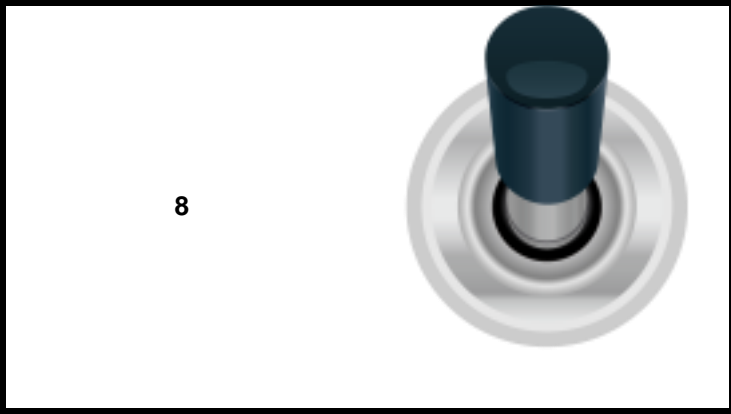

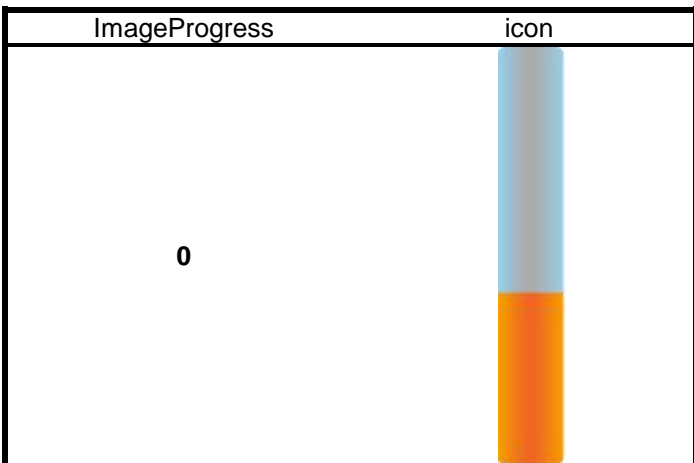
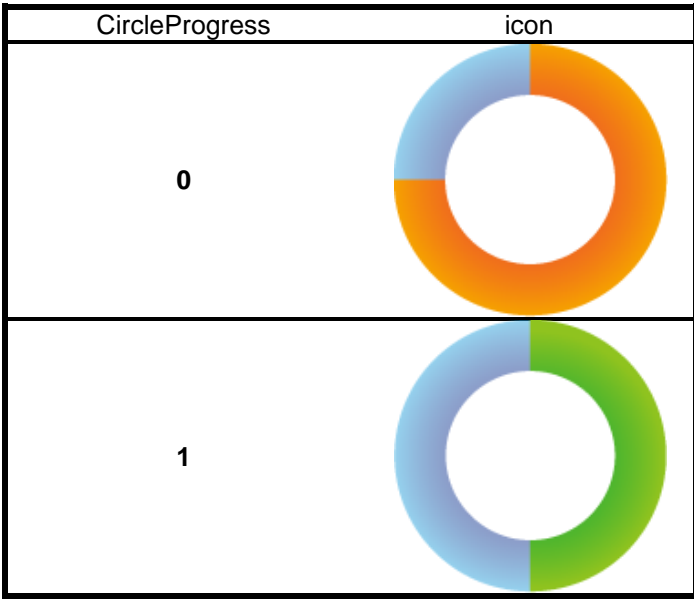
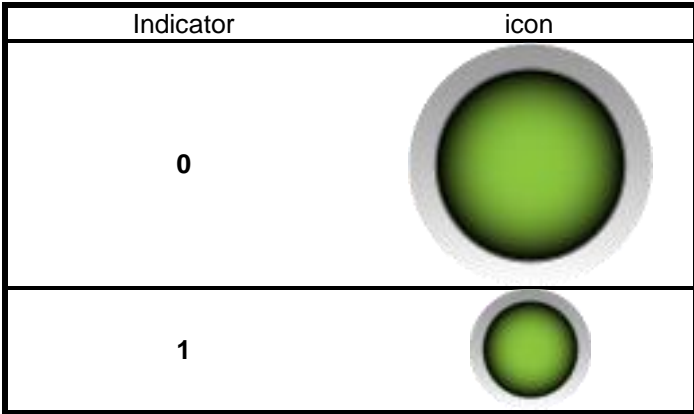
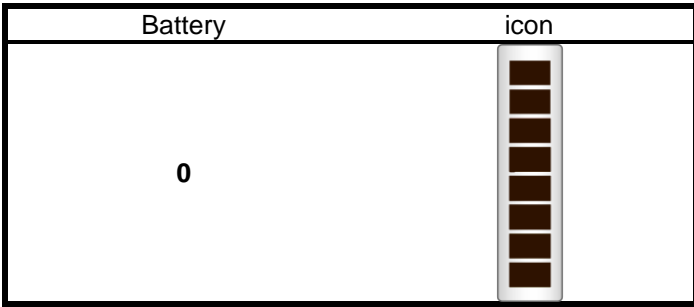

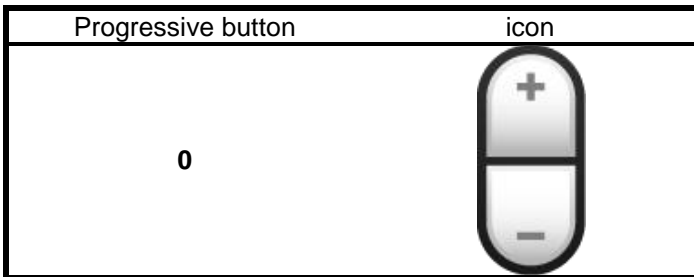
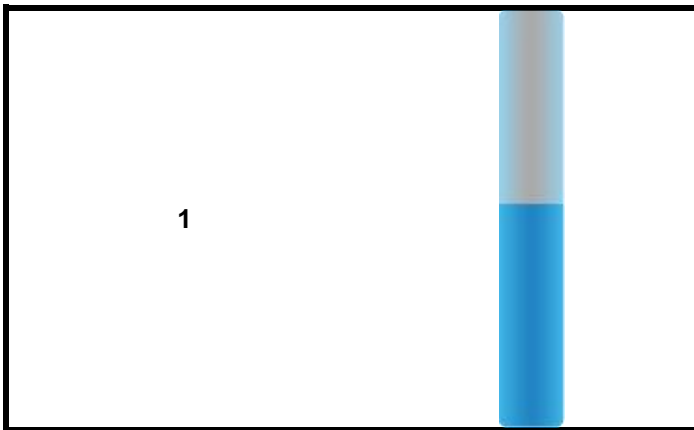

Number String	icon
0	65535
1	65535
2	65535

Text String	icon
0	ABC
1	ABC
2	ABC

Sub 7&8 –Data send and receive

HOST sends numeric data to Sub 7 to control Smart Display objects another HOST receives numerical data from Sub8.

HOST can be used on multiple platforms, such as **Computer, MCU, Raspberry Pi(with PiCAN2).**

Buzzer(0x2013)

Object Index 0x2013	Name	type	Description
Sub 0	Number of Entries	UNSIGNED8	9
Sub 1	Reserve		style of Object
Sub 2	Reserve		
Sub 3	Reserve		The object's X position
Sub 4	Active	BOOLEAN	Default value is False

The transmitted data must be mutually exclusive binary values. (If first send '1' then second data

must to send '0' and so on....)

Receive / Transmit PDO Mapping

The following table is showing RPDO mapping object index.

index	Sub-index	Name	Value
1600 (RPDO1)	Sub 0	Number of Entries	4
	Sub 1	PDO 1 Mapping for an application object 1	Value 1 (0x2000)
	Sub 2	PDO 1 Mapping for an application object 2	Value 1 (0x2001)
	Sub 3	PDO 1 Mapping for an application object 3	Value 1 (0x2002)
	Sub 4	PDO 1 Mapping for an application object 4	Value 1 (0x2003)
1601 (RPDO2)	Sub 0	Number of Entries	4
	Sub 1	PDO 1 Mapping for an application object 1	Value 1 (0x2004)
	Sub 2	PDO 1 Mapping for an application object 2	Value 1 (0x2005)
	Sub 3	PDO 1 Mapping for an application object 3	Value 1 (0x2006)
	Sub 4	PDO 1 Mapping for an application object 4	Value 1 (0x2007)
1602 (RPDO3)	Sub 0	Number of Entries	4
	Sub 1	PDO 1 Mapping for an application object 1	Value 1 (0x2008)
	Sub 2	PDO 1 Mapping for an application object 2	Value 1 (0x2009)
	Sub 3	PDO 1 Mapping for an application object 3	Active (0x2013)
	Sub 4	PDO 1 Mapping for an application object 4	None

The following table is showing TPDO mapping object index.

index	Sub-index	Name	Value
1A00 (TPDO1)	Sub 0	Number of Entries	4
	Sub 1	PDO 1 Mapping for a process data variable 1	Value 2 (0x2000)
	Sub 2	PDO 1 Mapping for a process data variable 2	Value 2 (0x2001)
	Sub 3	PDO 1 Mapping for a process data variable 3	Value 2 (0x2002)
	Sub 4	PDO 1 Mapping for a process data variable 4	Value 2 (0x2003)
1A01 (TPDO2)	Sub 0	Number of Entries	4
	Sub 1	PDO 1 Mapping for a process data variable 1	Value 2 (0x2004)
	Sub 2	PDO 1 Mapping for a process data variable 2	Value 2 (0x2005)
	Sub 3	PDO 1 Mapping for a process data variable 3	Value 2 (0x2006)
	Sub 4	PDO 1 Mapping for a process data variable 4	Value 2 (0x2007)
1A02 (TPDO3)	Sub 0	Number of Entries	2
	Sub 1	PDO 1 Mapping for a process data variable 1	Value 2 (0x2008)
	Sub 2	PDO 1 Mapping for a process data variable 2	Value 2 (0x2009)

13. Example Screen Layout (Vehicle automotive)

Example Layout

The screen layout described in this section is intended to demonstrate the settings of screen items that can be used in a vehicle automotive situation.



- 0x2000 Gauge
- 0x2001 Battery
- 0x2002 Temperature
- 0x2003 Toggle Button
- 0x2004 Toggle Button
- 0x2005 Indicator

14. References